

**EXISTING WINDOW
(TYPICAL - DOUBLE HUNG)**

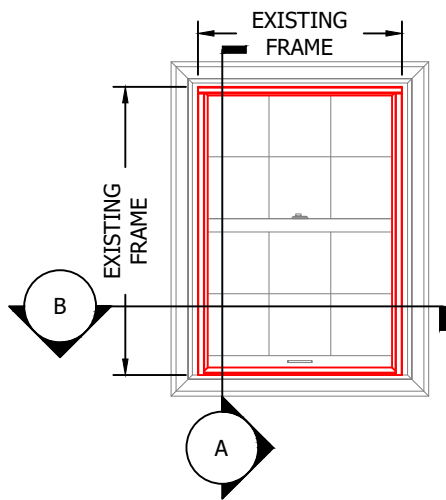

**STORM WINDOW ELEVATION
(COMPRESSION)**

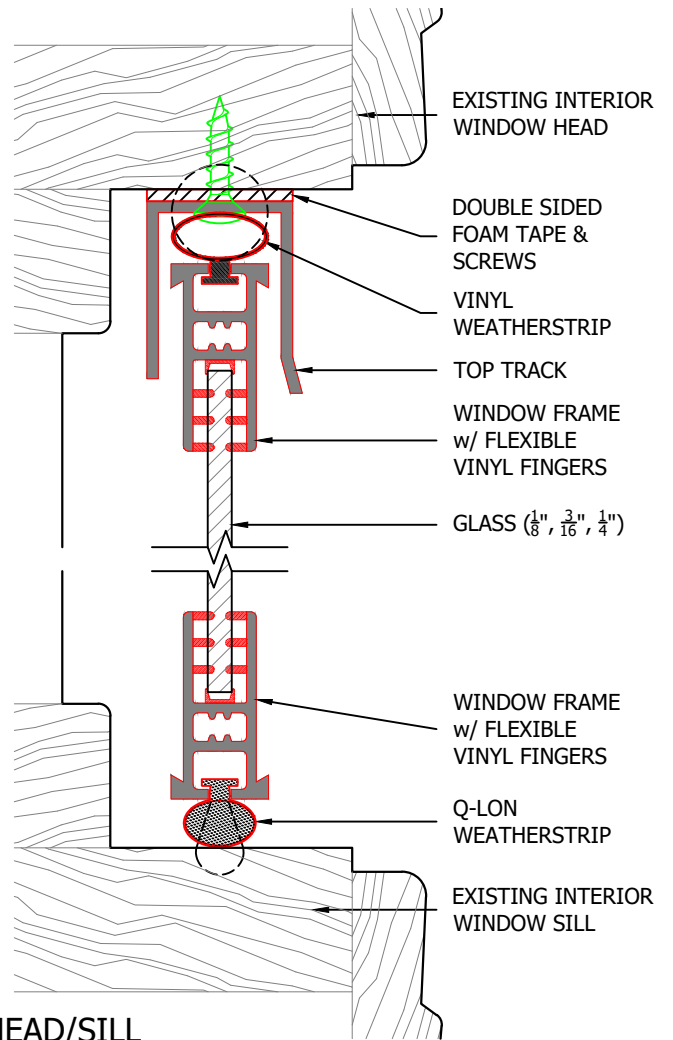

**A - HEAD/SILL
(FULL SCALE)**

- AVAILABLE IN ALMOND, BROWN AND WHITE
- SEE ADDITIONAL DETAILS FOR OVERSIZED WINDOWS

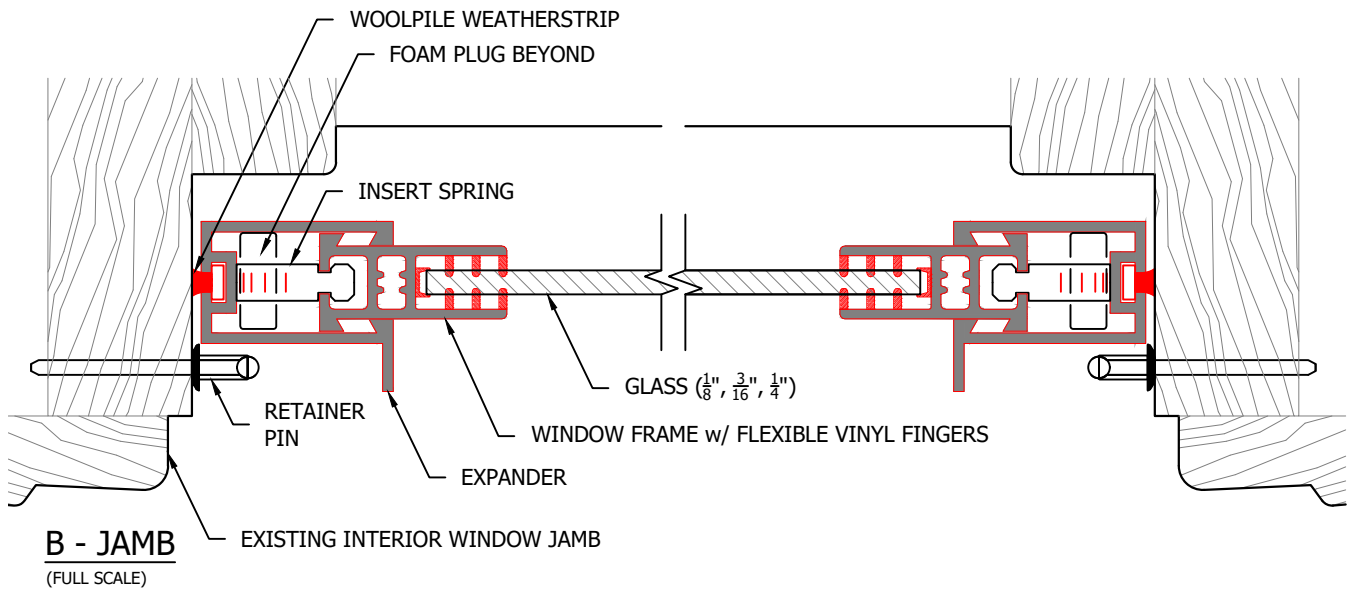

**B - JAMB
(FULL SCALE)**



Innerglass®
Window Systems, LLC
The Compression-Fit Advantage

PRODUCT CUT SHEET
COMPRESSION WINDOW
SECTIONS & DETAILS

DATE: 05/23/18

CP

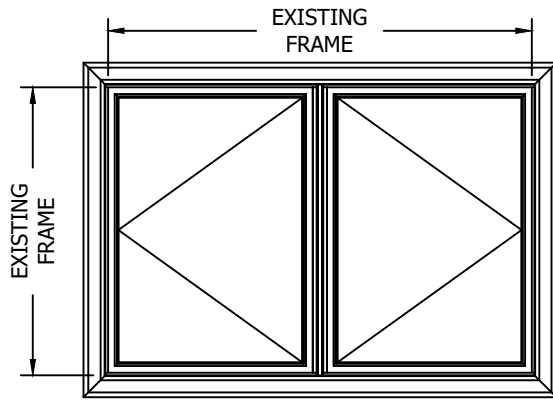

EXISTING WINDOW
(DOUBLE CASEMENT)

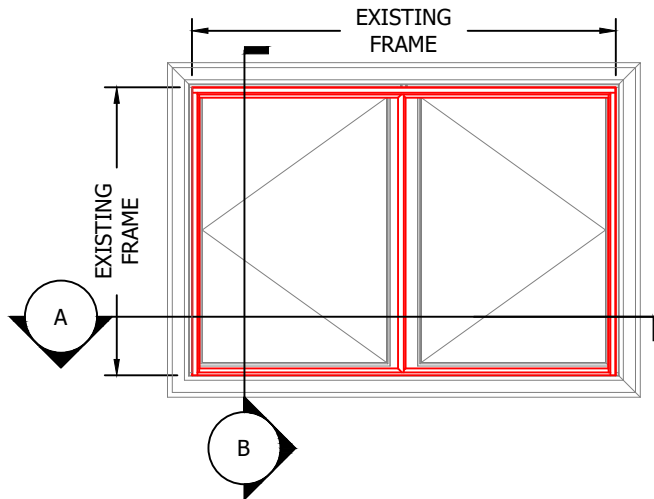

SLIDING STORM WINDOW
OVER DOUBLE CASEMENT

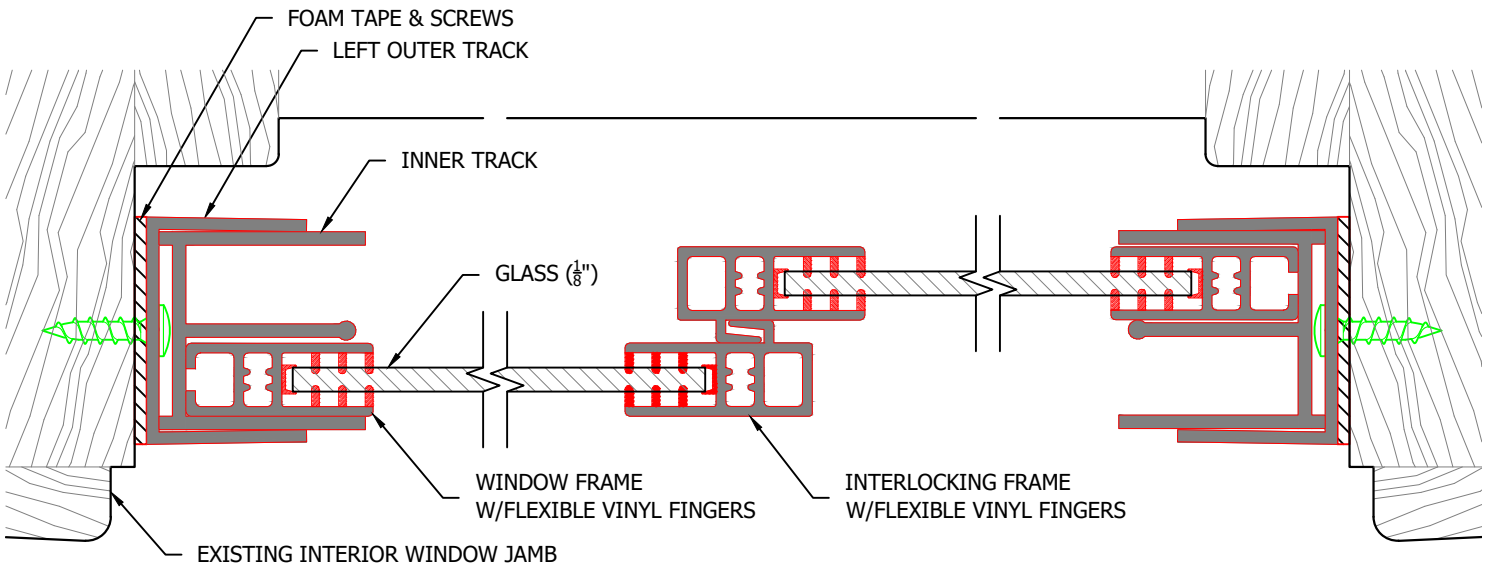

A - JAMB
(FULL SCALE)

- AVAILABLE IN ALMOND, BROWN AND WHITE
- SEE ADDITIONAL DETAILS FOR OVERSIZED WINDOWS
- AVAILABLE AS DOUBLE SLIDER (LEFT OR RIGHT OPENING) OR A TRIPLE SLIDER WHERE BOTH LEFT & RIGHT OPEN & CENTER IS STATIONARY



Innerglass[®]
Window Systems, LLC
The Compression-Fit Advantage

PRODUCT CUT SHEET
SLIDING INTERIOR STORM WINDOW

DATE: 05/23/18

SL₁

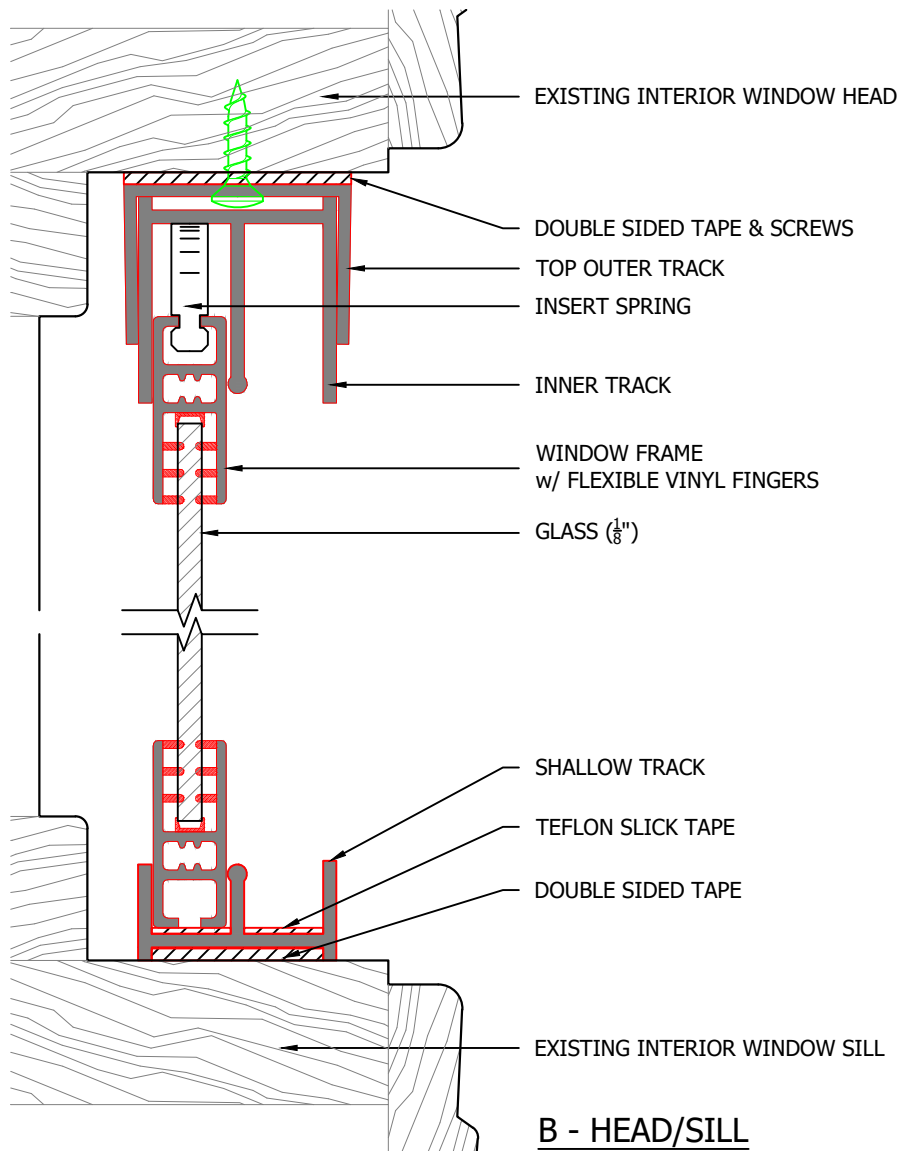

B - HEAD/SILL
(FULL SCALE)



Innerglass[®]
Window Systems, LLC
The Compression-Fit Advantage

PRODUCT CUT SHEET
SLIDING INTERIOR STORM WINDOW

DATE: 05/23/18

SL₂

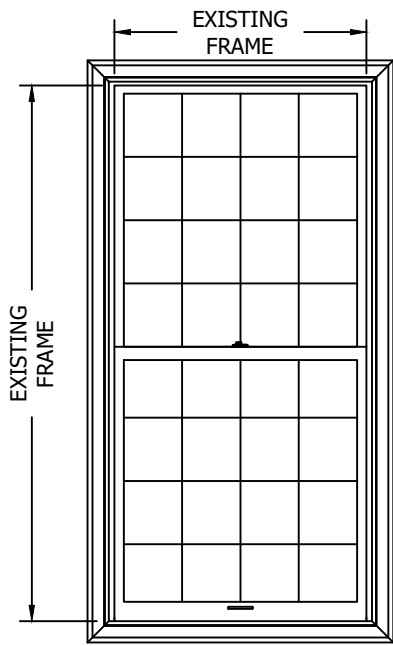

EXISTING DOUBLE HUNG WINDOW

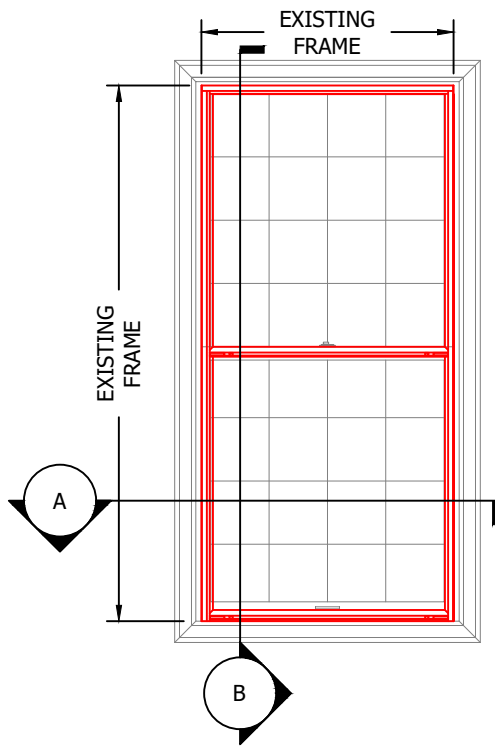

DOUBLE HUNG STORM WINDOW

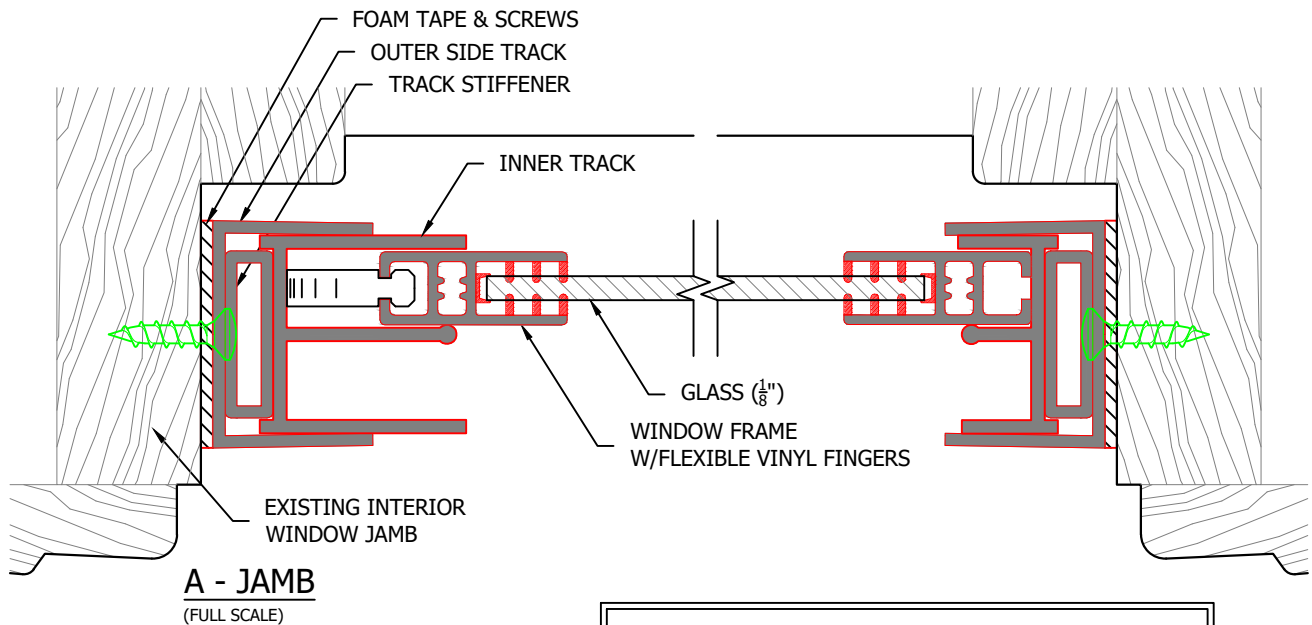

- AVAILABLE IN ALMOND, BROWN AND WHITE
- SEE ADDITIONAL DETAILS FOR OVERSIZED WINDOWS



Innerglass[®]
 Window Systems, LLC
 The Compression-Fit Advantage

PRODUCT CUT SHEET
 DOUBLE HUNG INTERIOR STORM WINDOW

 DATE: 05/23/18

DH₁

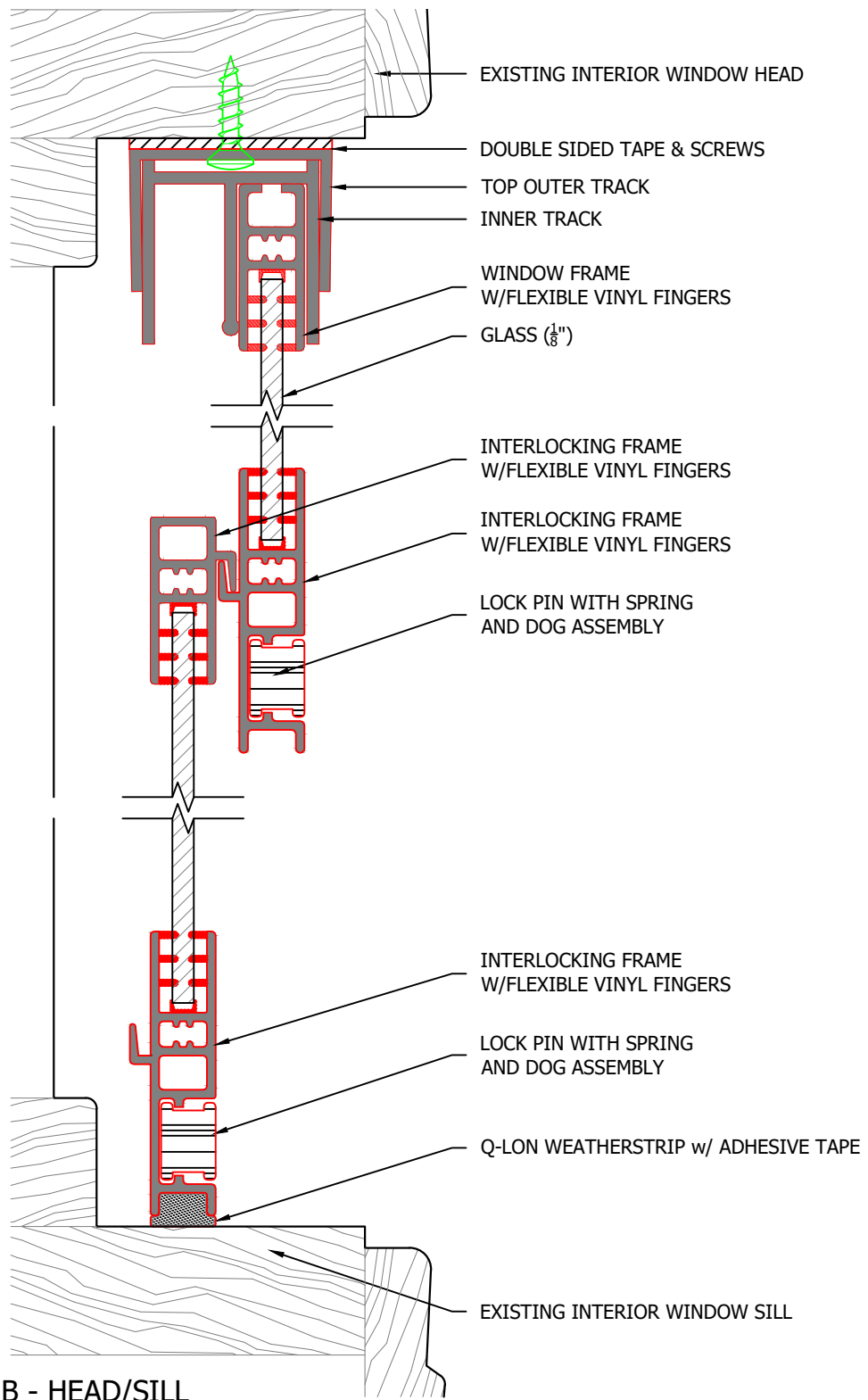

B - HEAD/SILL
(FULL SCALE)



PRODUCT CUT SHEET
 DOUBLE HUNG INTERIOR STORM WINDOW

 DATE: 05/23/18

DH₂

- AVAILABLE IN ALMOND, BROWN AND WHITE
- SEE ADDITIONAL DETAILS FOR OVERSIZED WINDOWS

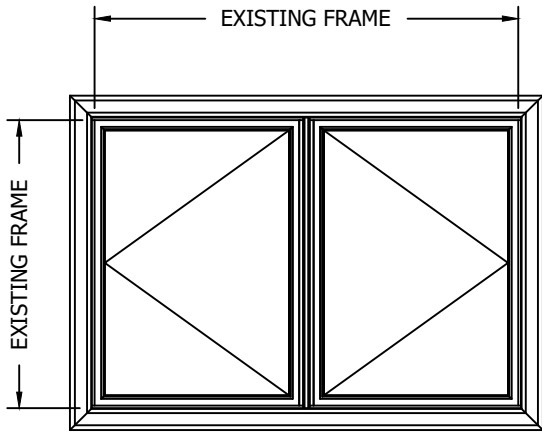

EXISTING WINDOW
(OVERSIZED - CASEMENT)

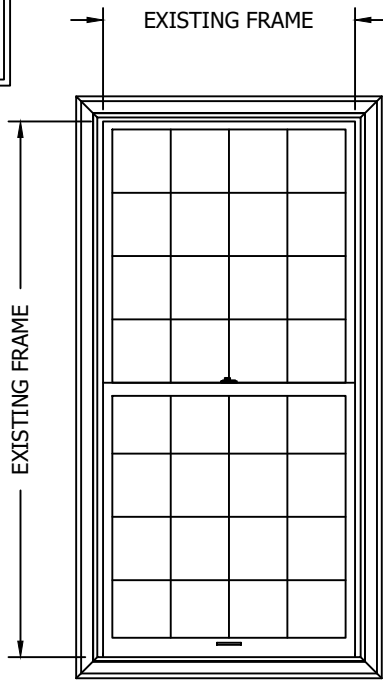

EXISTING WINDOW
(OVERSIZED - DOUBLE HUNG)

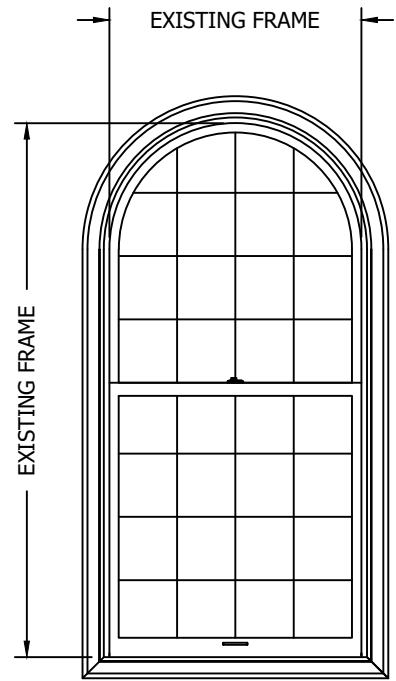

EXISTING WINDOW
(OVERSIZED - SINGLE HUNG
w/ ARCH TOP)

OVERSIZE OPENINGS CAN BE SPLIT UP WITH VERTICAL AND/OR HORIZONTAL MULLION POSTS AT THE EXISTING SIGHTLINES. COMBINATIONS OF DIFFERENT INTERIOR STORM WINDOWS CAN THEN BE INSTALLED AS DESIRED. EXAMPLE: A 4ft x 8ft DOUBLE HUNG COULD BE SPLIT WITH A HORIZONTAL MULLION POST AT THE MEETING RAIL AND HAVE A COMPRESSION WINDOW IN THE TOP SECTION AND A HORIZONTAL SLIDER IN THE BOTTOM SECTION.

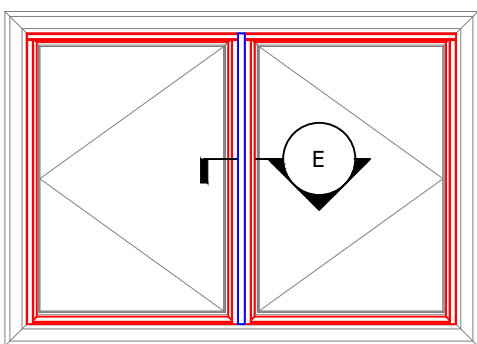

STORM WINDOW ELEVATION
(VERTICAL MULLION)

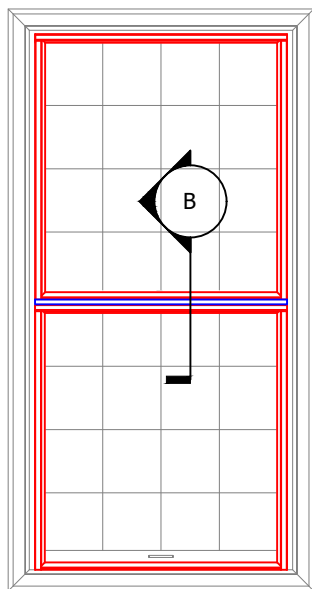

STORM WINDOW ELEVATION
(HORIZONTAL MULLION)

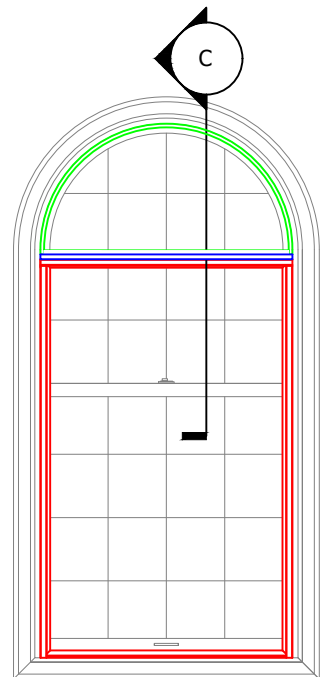

STORM WINDOW ELEVATION
(HORIZONTAL MULLION
w/ 1/8" DEADLITE)



PRODUCT CUT SHEET
OVERSIZE OPENINGS SPLIT w/ MULLION POSTS
BASIC CONFIGURATIONS

DATE: 05/23/18

M₁

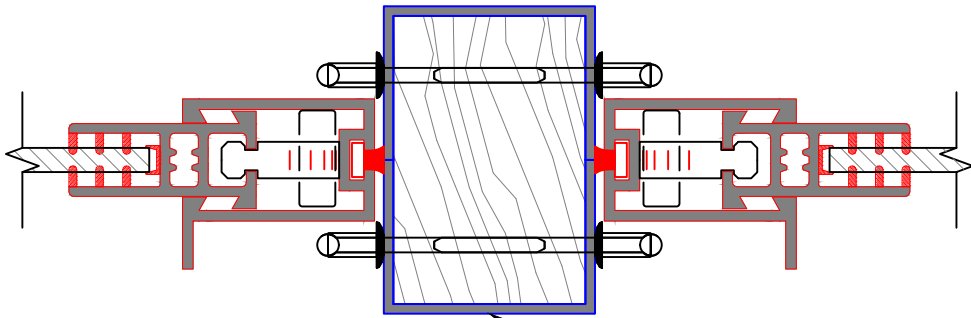

VERTICAL MULLION (VINYL SLEEVES OVER WOOD POST SECURED TO HEAD & SILL w/ POCKET SCREWS)

A - MULLION (VERTICAL)

OVERSIZE OPENINGS CAN BE SPLIT UP WITH VERTICAL AND/OR HORIZONTAL MULLION POSTS AT THE EXISTING SIGHTLINES. COMBINATIONS OF DIFFERENT INTERIOR STORM WINDOWS CAN THEN BE INSTALLED AS DESIRED. EXAMPLE: A 4ft x 8ft DOUBLE HUNG COULD BE SPLIT WITH A HORIZONTAL MULLION POST AT THE MEETING RAIL AND HAVE A COMPRESSION WINDOW IN THE TOP SECTION AND A HORIZONTAL SLIDER IN THE BOTTOM SECTION.

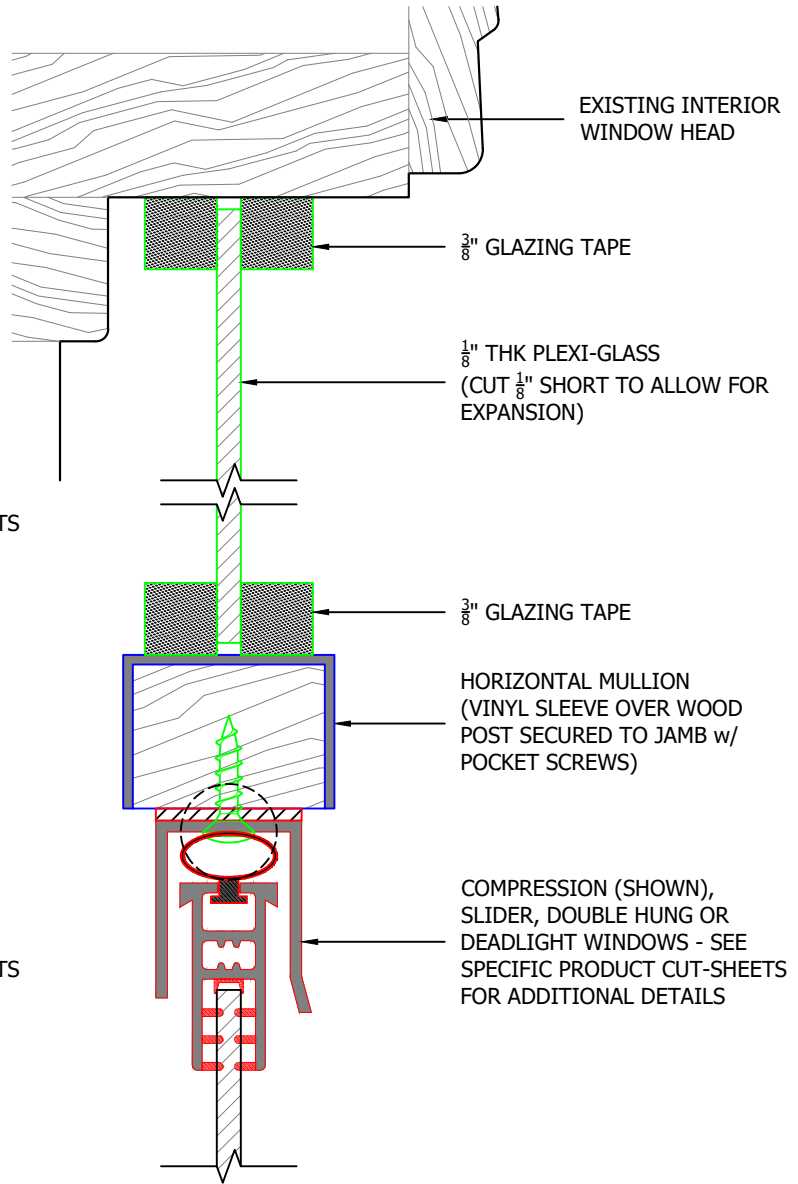

EXISTING INTERIOR WINDOW HEAD

3/8" GLAZING TAPE

1/8" THK PLEXI-GLASS (CUT 1/8" SHORT TO ALLOW FOR EXPANSION)

3/8" GLAZING TAPE

HORIZONTAL MULLION (VINYL SLEEVE OVER WOOD POST SECURED TO JAMB w/ POCKET SCREWS)

COMPRESSION (SHOWN), SLIDER, DOUBLE HUNG OR DEADLIGHT WINDOWS - SEE SPECIFIC PRODUCT CUT-SHEETS FOR ADDITIONAL DETAILS

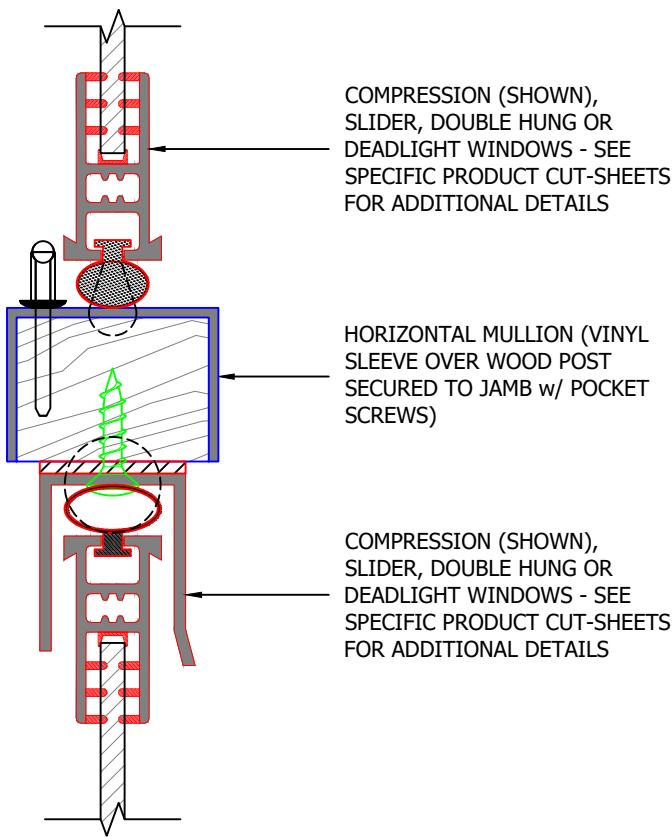

COMPRESSION (SHOWN), SLIDER, DOUBLE HUNG OR DEADLIGHT WINDOWS - SEE SPECIFIC PRODUCT CUT-SHEETS FOR ADDITIONAL DETAILS

HORIZONTAL MULLION (VINYL SLEEVE OVER WOOD POST SECURED TO JAMB w/ POCKET SCREWS)

COMPRESSION (SHOWN), SLIDER, DOUBLE HUNG OR DEADLIGHT WINDOWS - SEE SPECIFIC PRODUCT CUT-SHEETS FOR ADDITIONAL DETAILS

B - HORIZONTAL MULLION

C - HORIZONTAL MULLION w/ DEADLITE



PRODUCT CUT SHEET
 OVERSIZE OPENINGS SPLIT w/ MULLION POSTS
 BASIC CONFIGURATIONS

 DATE: 05/23/18

M₂



EX: 6

OVERSIZE OPENINGS CAN BE SPLIT UP WITH VERTICAL AND/OR HORIZONTAL MULLION POSTS AT THE EXISTING SIGHTLINES. COMBINATIONS OF DIFFERENT INTERIOR STORM WINDOWS CAN THEN BE INSTALLED AS DESIRED. EXAMPLE: A 4ft x 8ft DOUBLE HUNG COULD BE SPLIT WITH A HORIZONTAL MULLION POST AT THE MEETING RAIL AND HAVE A COMPRESSION WINDOW IN THE TOP SECTION AND A HORIZONTAL SLIDER IN THE BOTTOM SECTION.

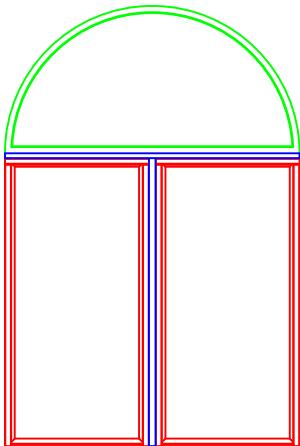

EX: 4

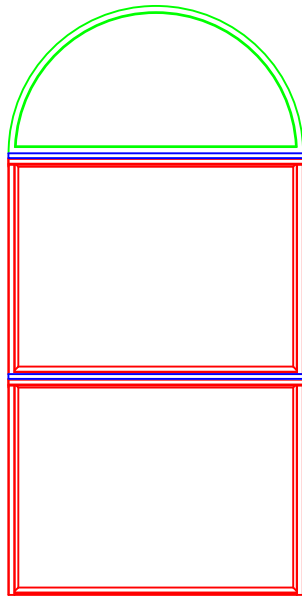

EX: 5

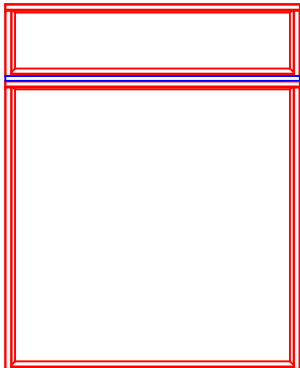

EX: 1

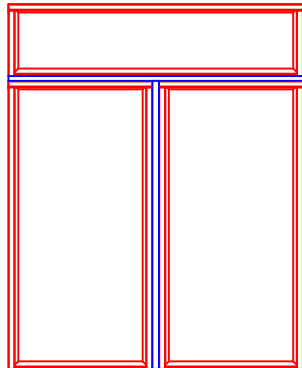

EX: 2

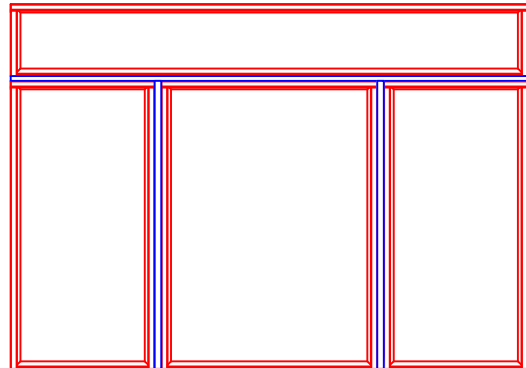

EX: 3



Innerglass[®]
 Window Systems, LLC
 The Compression-Fit Advantage

PRODUCT CUT SHEET
 OVERSIZE OPENINGS SPLIT w/ MULLION POSTS
 ADDITIONAL CONFIGURATIONS

DATE: 05/23/18

M₃

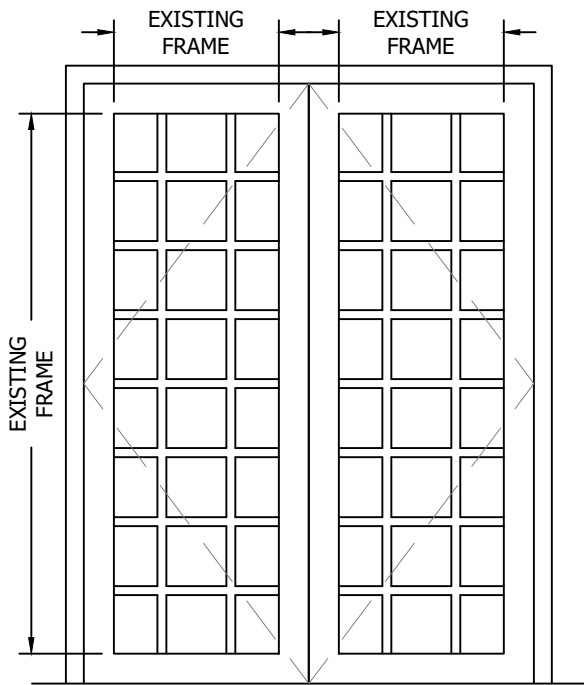

EXISTING WINDOW

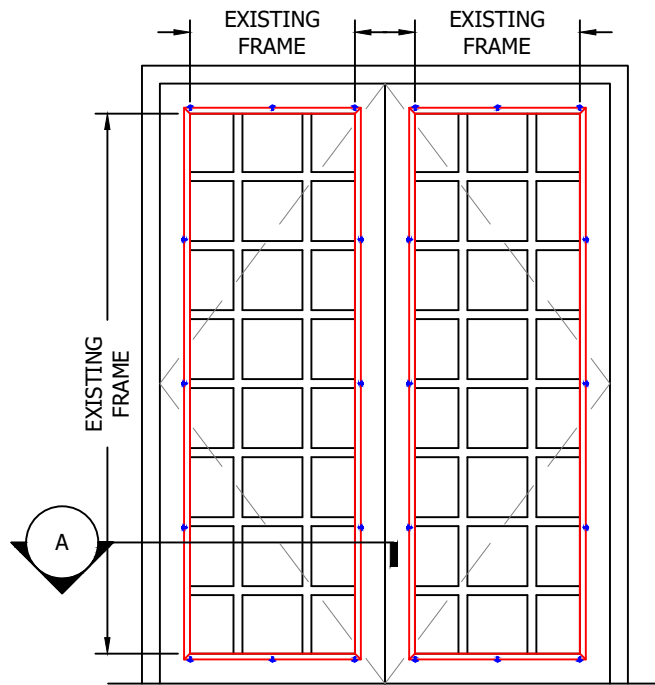

WINDOW ELEVATION

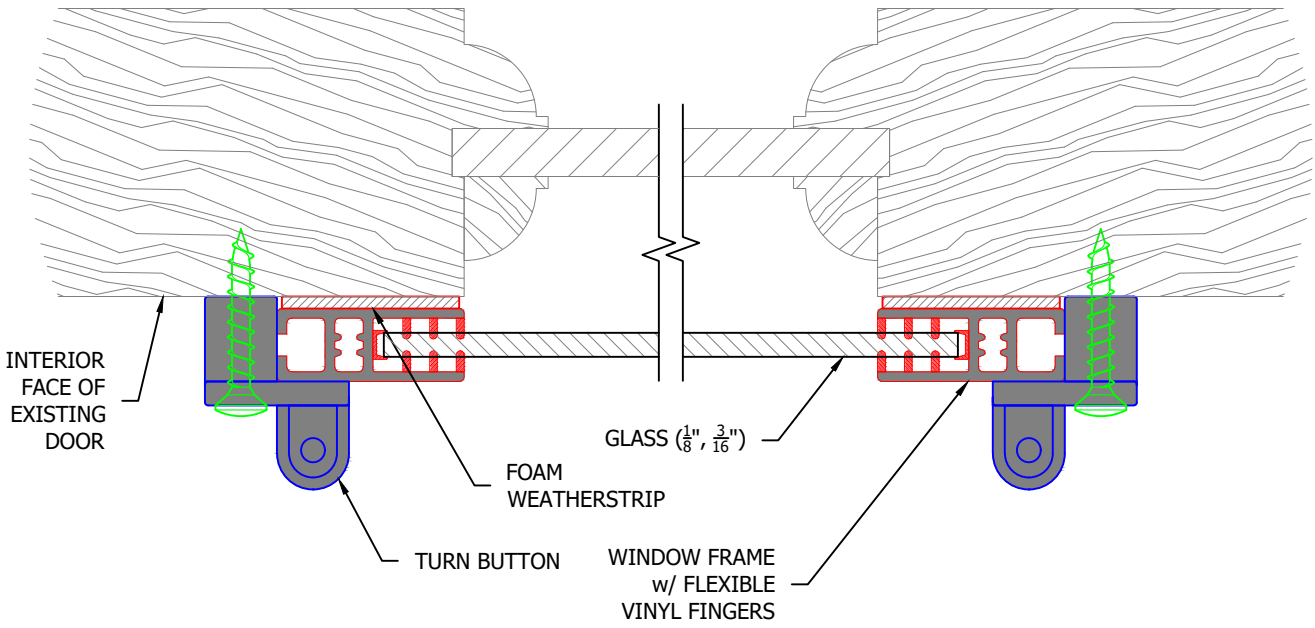

A - FRAME
(FULL SCALE)

- AVAILABLE IN ALMOND, BROWN AND WHITE
- SEE ADDITIONAL DETAILS FOR OVERSIZED WINDOWS



Innerglass[®]
Window Systems, LLC
The Compression-Fit Advantage

PRODUCT CUT SHEET
SURFACE MOUNT INTERIOR STORM WINDOW

DATE: 05/23/18

SM