

**EXISTING WINDOW  
(TYPICAL - DOUBLE HUNG)**

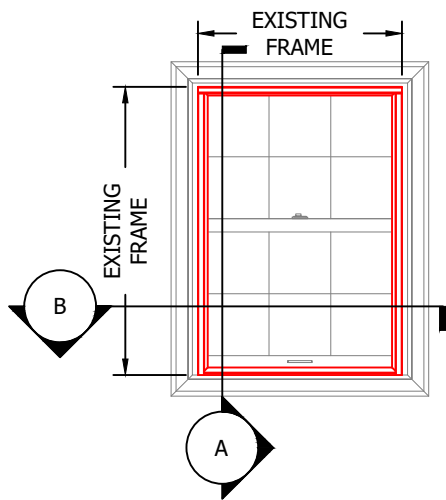

**STORM WINDOW ELEVATION  
(COMPRESSION)**

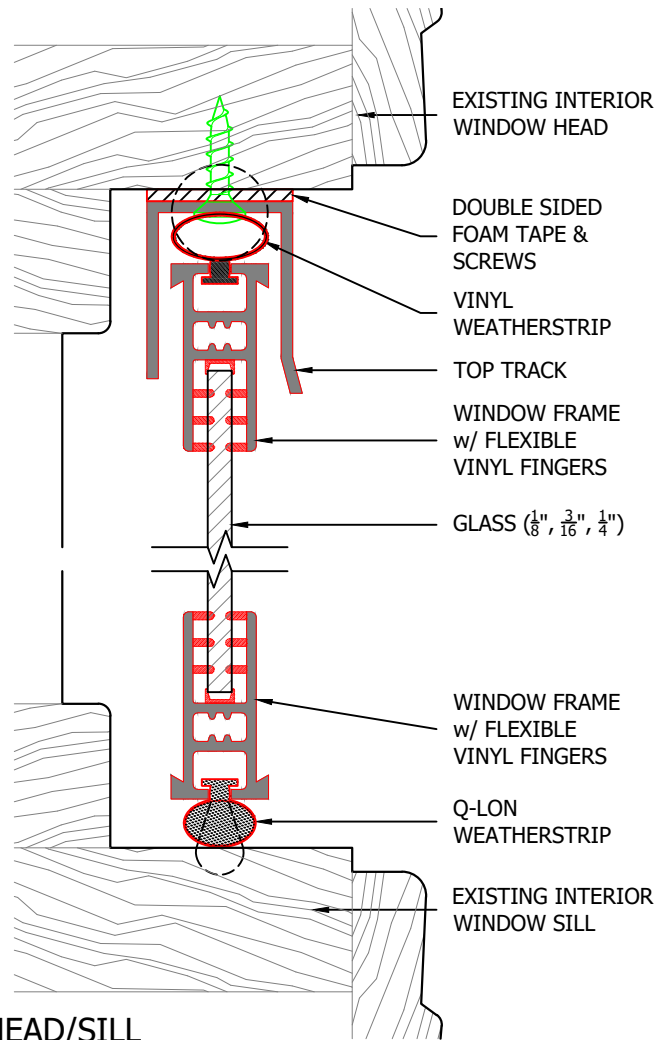

**A - HEAD/SILL  
(FULL SCALE)**

- AVAILABLE IN ALMOND, BROWN AND WHITE
- SEE ADDITIONAL DETAILS FOR OVERSIZED WINDOWS

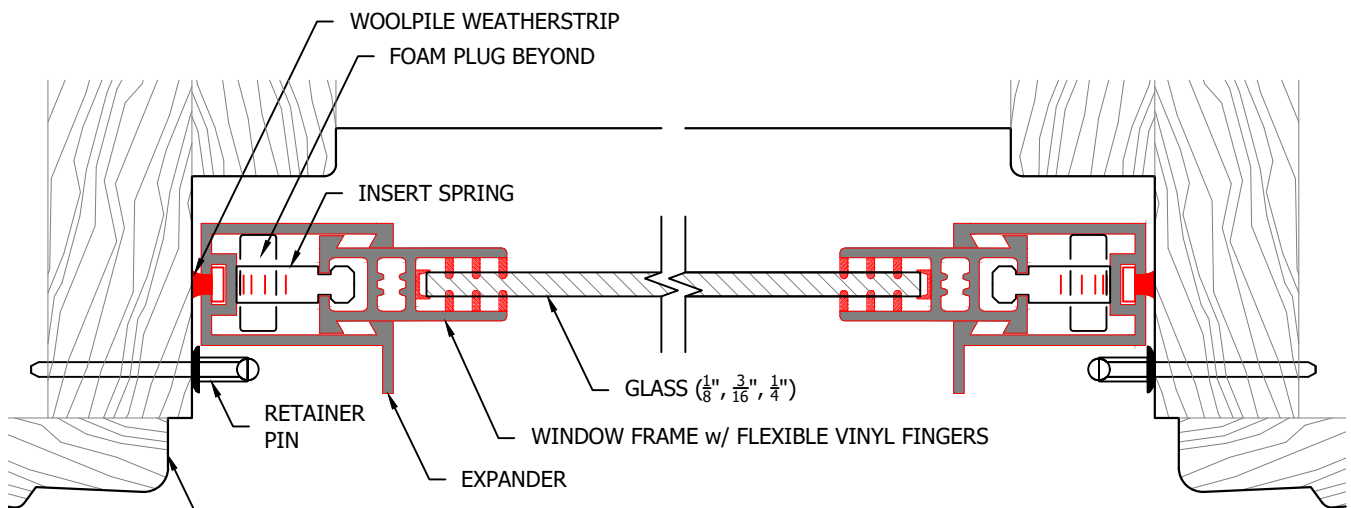

**B - JAMB  
(FULL SCALE)**



**Innerglass®**  
Window Systems, LLC  
The Compression-Fit Advantage

PRODUCT CUT SHEET  
COMPRESSION WINDOW  
SECTIONS & DETAILS

DATE: 05/23/18

**CP**

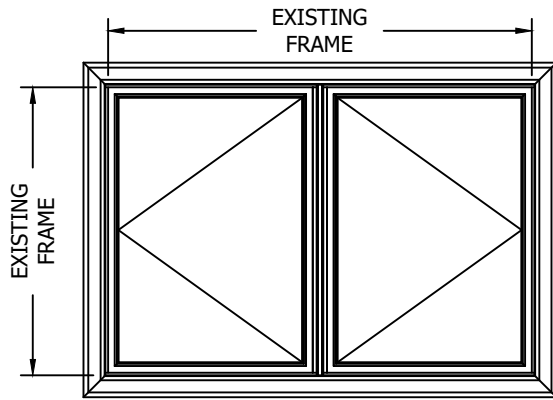

EXISTING WINDOW  
(DOUBLE CASEMENT)

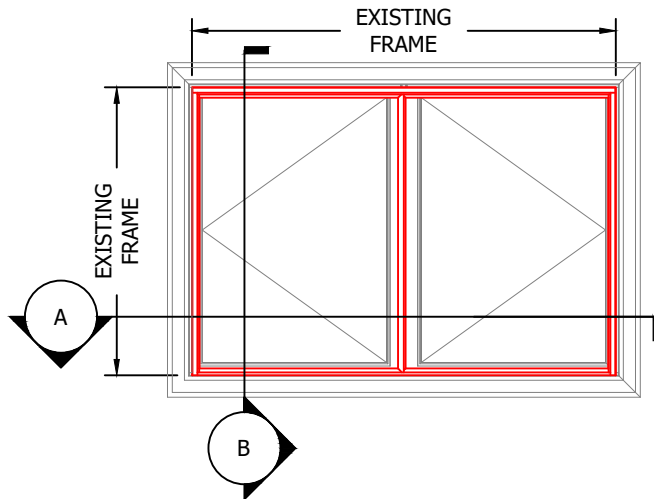

SLIDING STORM WINDOW  
OVER DOUBLE CASEMENT

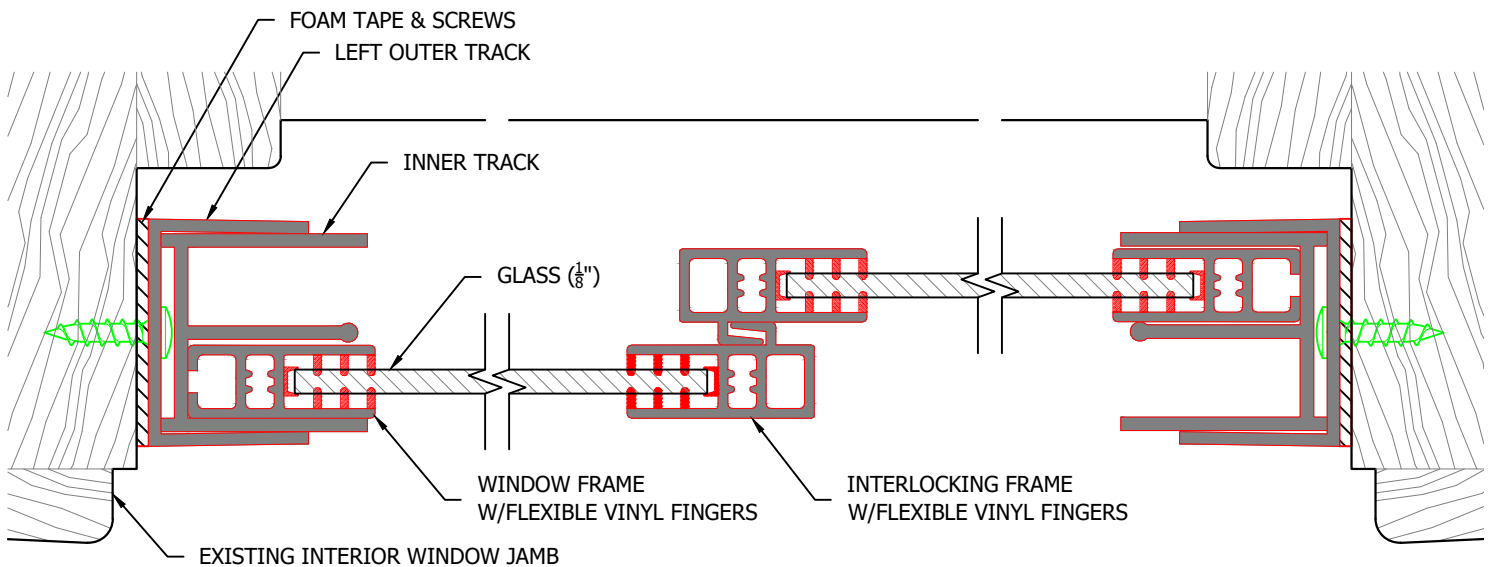

A - JAMB  
(FULL SCALE)

- AVAILABLE IN ALMOND, BROWN AND WHITE
- SEE ADDITIONAL DETAILS FOR OVERSIZED WINDOWS
- AVAILABLE AS DOUBLE SLIDER (LEFT OR RIGHT OPENING) OR A TRIPLE SLIDER WHERE BOTH LEFT & RIGHT OPEN & CENTER IS STATIONARY



**Innerglass**

Window Systems, LLC  
The Compression-Fit Advantage

PRODUCT CUT SHEET  
SLIDING INTERIOR STORM WINDOW

DATE: 05/23/18

**SL<sub>1</sub>**

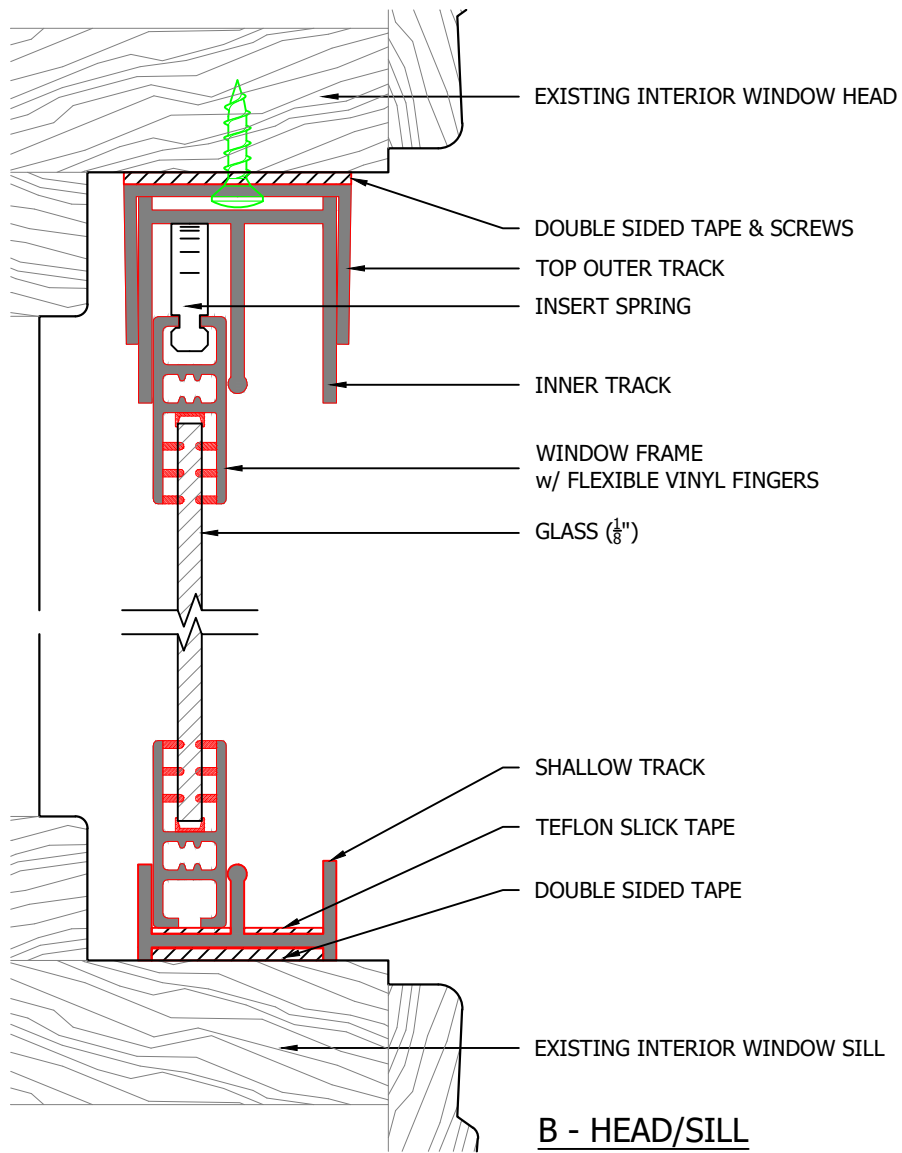

**B - HEAD/SILL**  
(FULL SCALE)



**Innerglass**<sup>®</sup>  
Window Systems, LLC  
The Compression-Fit Advantage

PRODUCT CUT SHEET  
SLIDING INTERIOR STORM WINDOW  
\_\_\_\_\_  
\_\_\_\_\_  
DATE: 05/23/18

**SL<sub>2</sub>**

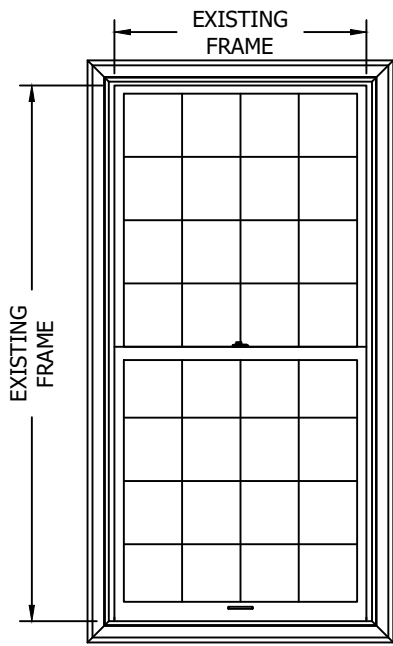

EXISTING DOUBLE HUNG WINDOW

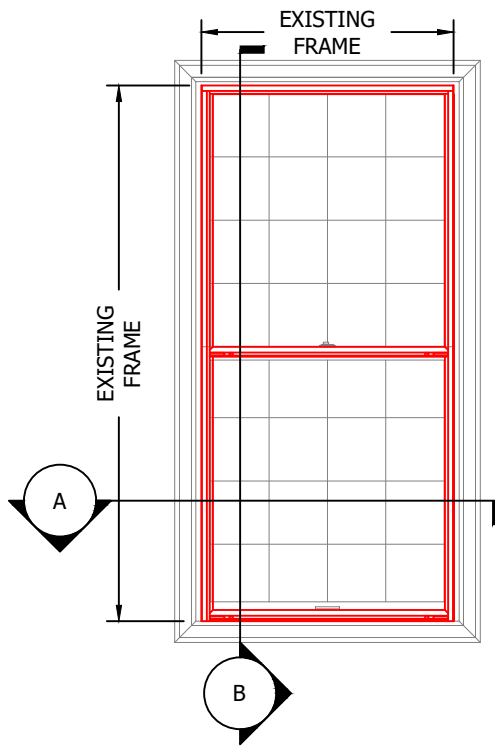

DOUBLE HUNG STORM WINDOW

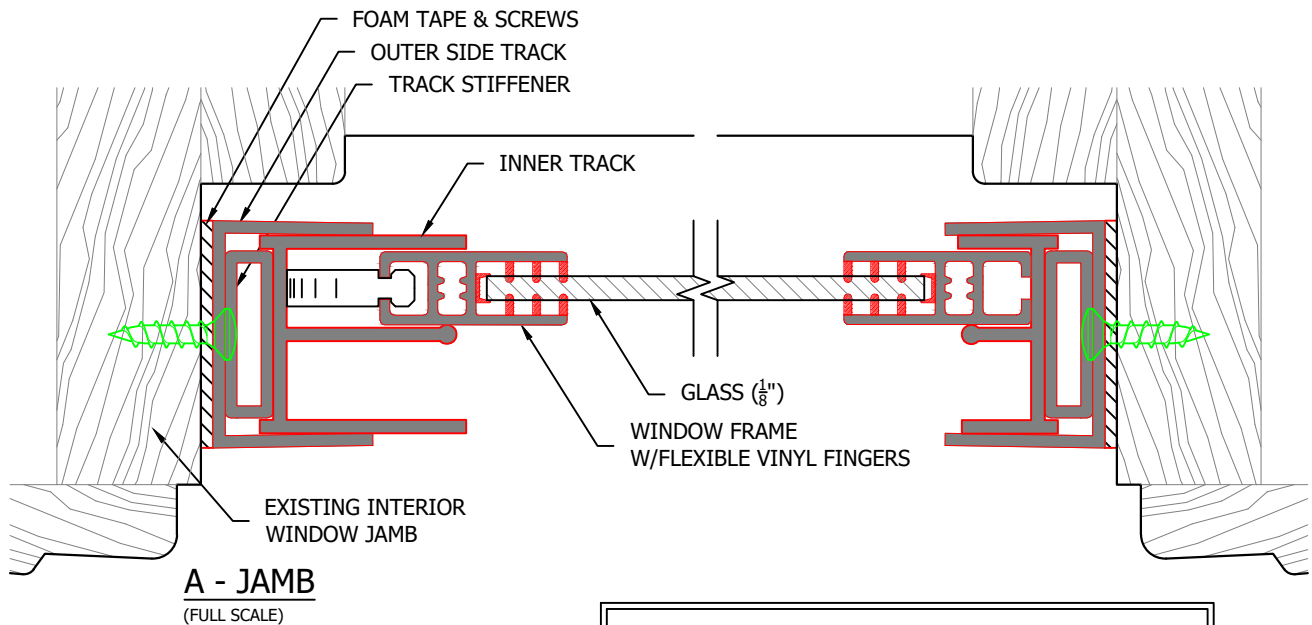

- AVAILABLE IN ALMOND, BROWN AND WHITE
- SEE ADDITIONAL DETAILS FOR OVERSIZED WINDOWS



**Innerglass**<sup>®</sup>  
Window Systems, LLC  
The Compression-Fit Advantage

PRODUCT CUT SHEET  
DOUBLE HUNG INTERIOR STORM WINDOW  
\_\_\_\_\_  
\_\_\_\_\_  
DATE: 05/23/18

**DH<sub>1</sub>**

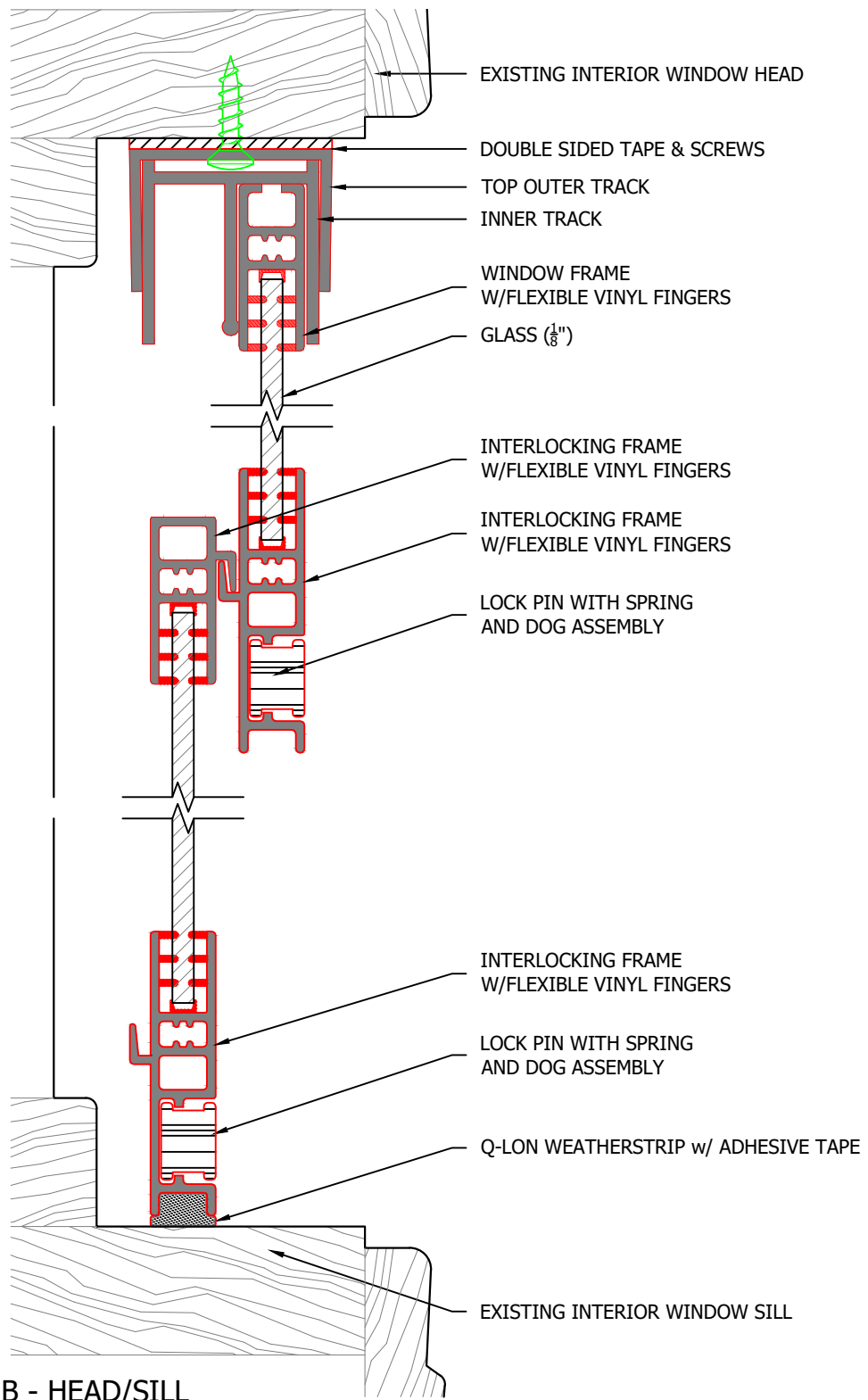

**B - HEAD/SILL**  
(FULL SCALE)



PRODUCT CUT SHEET  
 DOUBLE HUNG INTERIOR STORM WINDOW  
 \_\_\_\_\_  
 \_\_\_\_\_  
 \_\_\_\_\_  
 DATE: 05/23/18

**DH<sub>2</sub>**

- AVAILABLE IN ALMOND, BROWN AND WHITE
- SEE ADDITIONAL DETAILS FOR OVERSIZED WINDOWS

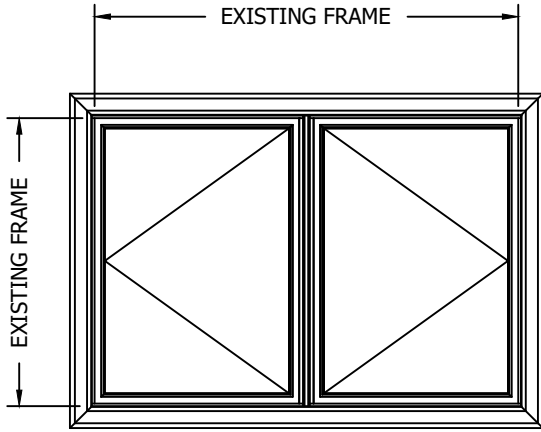

EXISTING WINDOW  
(OVERSIZED - CASEMENT)

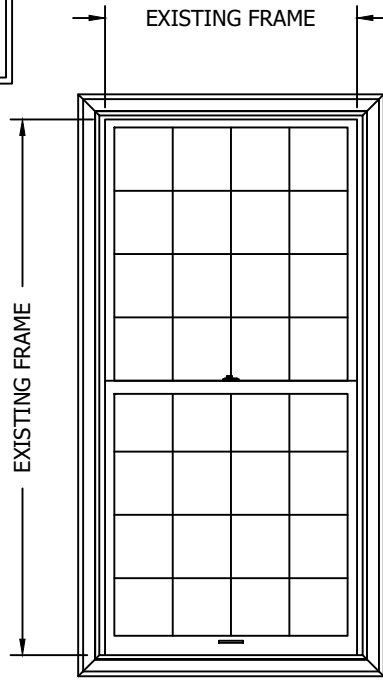

EXISTING WINDOW  
(OVERSIZED - DOUBLE HUNG)

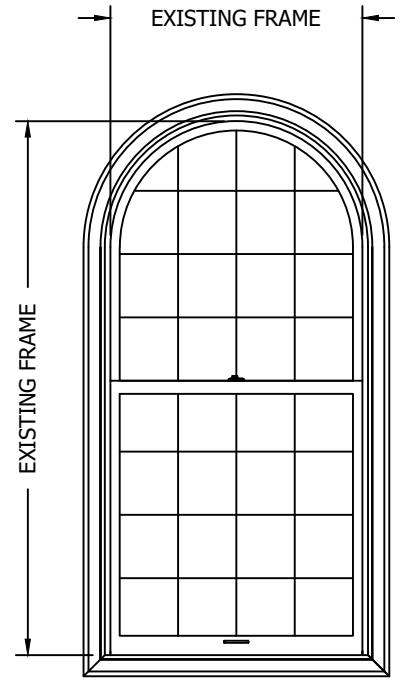

EXISTING WINDOW  
(OVERSIZED - SINGLE HUNG  
w/ ARCH TOP)

OVERSIZE OPENINGS CAN BE SPLIT UP WITH VERTICAL AND/OR HORIZONTAL MULLION POSTS AT THE EXISTING SIGHTLINES. COMBINATIONS OF DIFFERENT INTERIOR STORM WINDOWS CAN THEN BE INSTALLED AS DESIRED. EXAMPLE: A 4ft x 8ft DOUBLE HUNG COULD BE SPLIT WITH A HORIZONTAL MULLION POST AT THE MEETING RAIL AND HAVE A COMPRESSION WINDOW IN THE TOP SECTION AND A HORIZONTAL SLIDER IN THE BOTTOM SECTION.

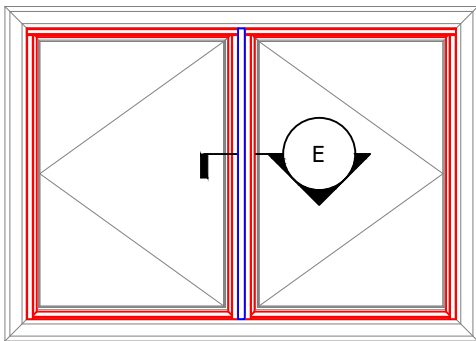

STORM WINDOW ELEVATION  
(VERTICAL MULLION)

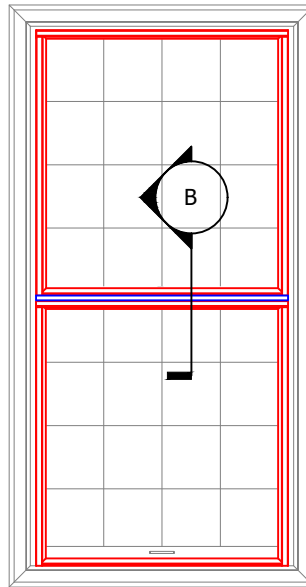

STORM WINDOW ELEVATION  
(HORIZONTAL MULLION)

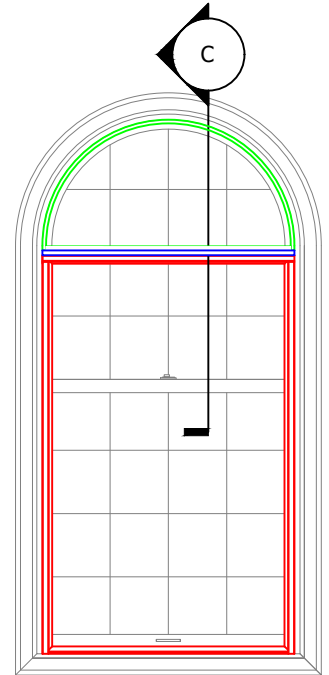

STORM WINDOW ELEVATION  
(HORIZONTAL MULLION  
w/ 1/8" DEADLITE)



**Innerglass**<sup>®</sup>  
Window Systems, LLC  
The Compression-Fit Advantage

PRODUCT CUT SHEET  
OVERSIZE OPENINGS SPLIT w/ MULLION POSTS  
BASIC CONFIGURATIONS

DATE: 05/23/18

M<sub>1</sub>

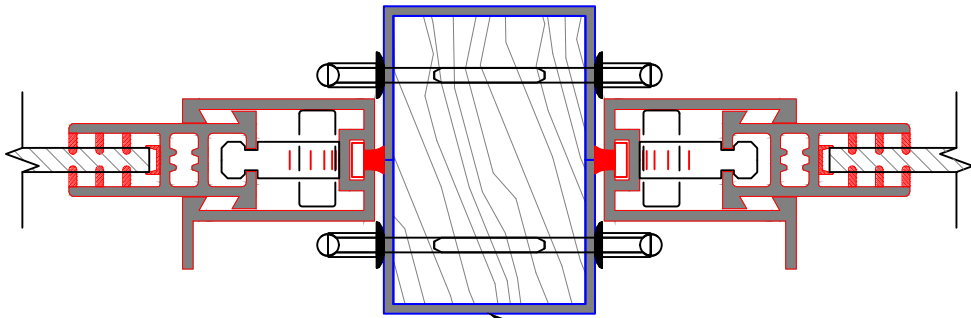

**A - MULLION (VERTICAL)**

(FULL SCALE)

VERTICAL MULLION (VINYL SLEEVES OVER WOOD POST SECURED TO HEAD & SILL w/ POCKET SCREWS)

OVERSIZE OPENINGS CAN BE SPLIT UP WITH VERTICAL AND/OR HORIZONTAL MULLION POSTS AT THE EXISTING SIGHTLINES. COMBINATIONS OF DIFFERENT INTERIOR STORM WINDOWS CAN THEN BE INSTALLED AS DESIRED. EXAMPLE: A 4ft x 8ft DOUBLE HUNG COULD BE SPLIT WITH A HORIZONTAL MULLION POST AT THE MEETING RAIL AND HAVE A COMPRESSION WINDOW IN THE TOP SECTION AND A HORIZONTAL SLIDER IN THE BOTTOM SECTION.

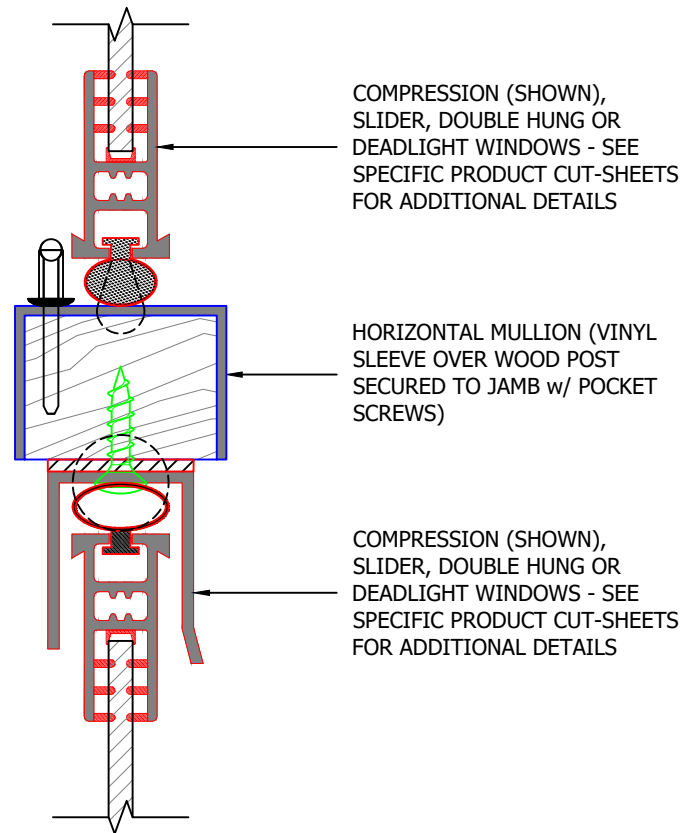
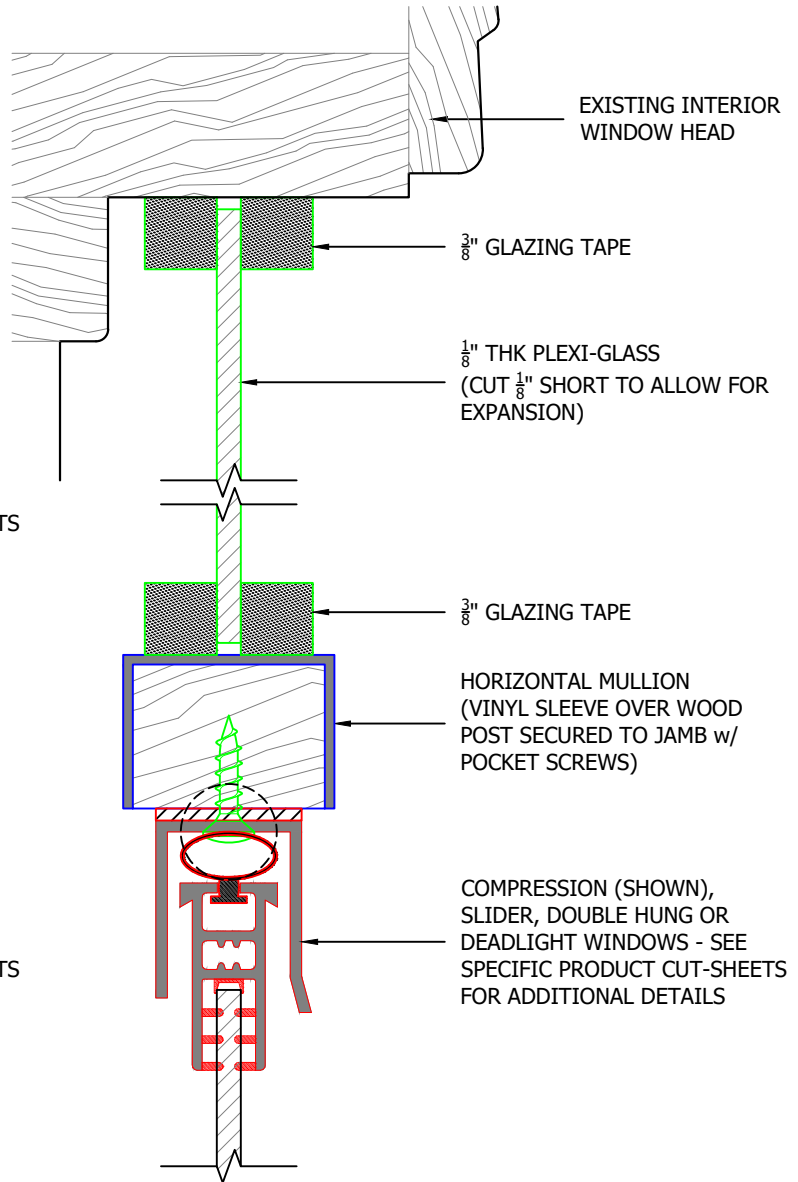

**B - HORIZONTAL MULLION**

(FULL SCALE)

COMPRESSION (SHOWN), SLIDER, DOUBLE HUNG OR DEADLIGHT WINDOWS - SEE SPECIFIC PRODUCT CUT-SHEETS FOR ADDITIONAL DETAILS

HORIZONTAL MULLION (VINYL SLEEVE OVER WOOD POST SECURED TO JAMB w/ POCKET SCREWS)

COMPRESSION (SHOWN), SLIDER, DOUBLE HUNG OR DEADLIGHT WINDOWS - SEE SPECIFIC PRODUCT CUT-SHEETS FOR ADDITIONAL DETAILS

**C - HORIZONTAL MULLION w/ DEADLITE**

(FULL SCALE)

EXISTING INTERIOR WINDOW HEAD

3/8" GLAZING TAPE

1/8" THK PLEXI-GLASS (CUT 1/8" SHORT TO ALLOW FOR EXPANSION)

3/8" GLAZING TAPE

HORIZONTAL MULLION (VINYL SLEEVE OVER WOOD POST SECURED TO JAMB w/ POCKET SCREWS)

COMPRESSION (SHOWN), SLIDER, DOUBLE HUNG OR DEADLIGHT WINDOWS - SEE SPECIFIC PRODUCT CUT-SHEETS FOR ADDITIONAL DETAILS



**Innerglass**  
Window Systems, LLC  
The Compression-Fit Advantage

PRODUCT CUT SHEET  
OVERSIZE OPENINGS SPLIT w/ MULLION POSTS  
BASIC CONFIGURATIONS

DATE: 05/23/18

M<sub>2</sub>



EX: 6

OVERSIZE OPENINGS CAN BE SPLIT UP WITH VERTICAL AND/OR HORIZONTAL MULLION POSTS AT THE EXISTING SIGHTLINES. COMBINATIONS OF DIFFERENT INTERIOR STORM WINDOWS CAN THEN BE INSTALLED AS DESIRED. EXAMPLE: A 4ft x 8ft DOUBLE HUNG COULD BE SPLIT WITH A HORIZONTAL MULLION POST AT THE MEETING RAIL AND HAVE A COMPRESSION WINDOW IN THE TOP SECTION AND A HORIZONTAL SLIDER IN THE BOTTOM SECTION.

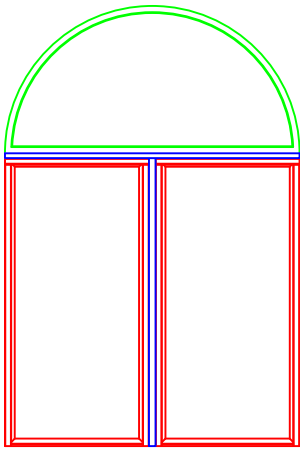

EX: 4

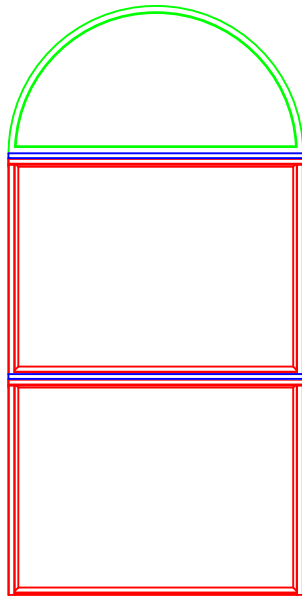

EX: 5

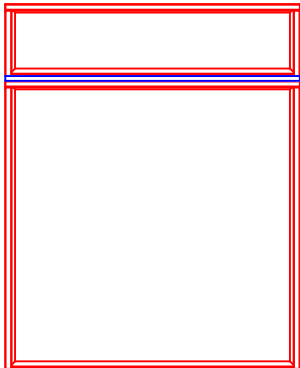

EX: 1

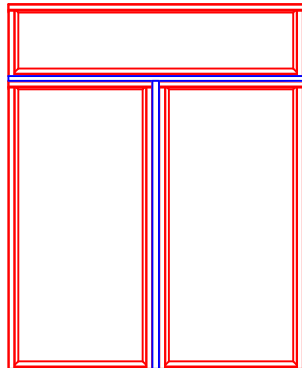

EX: 2

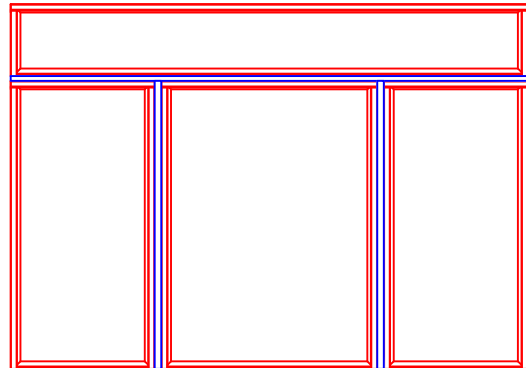

EX: 3



**Innerglass**<sup>®</sup>  
 Window Systems, LLC  
 The Compression-Fit Advantage

PRODUCT CUT SHEET  
 OVERSIZE OPENINGS SPLIT w/ MULLION POSTS  
 ADDITIONAL CONFIGURATIONS

DATE: 05/23/18

M<sub>3</sub>



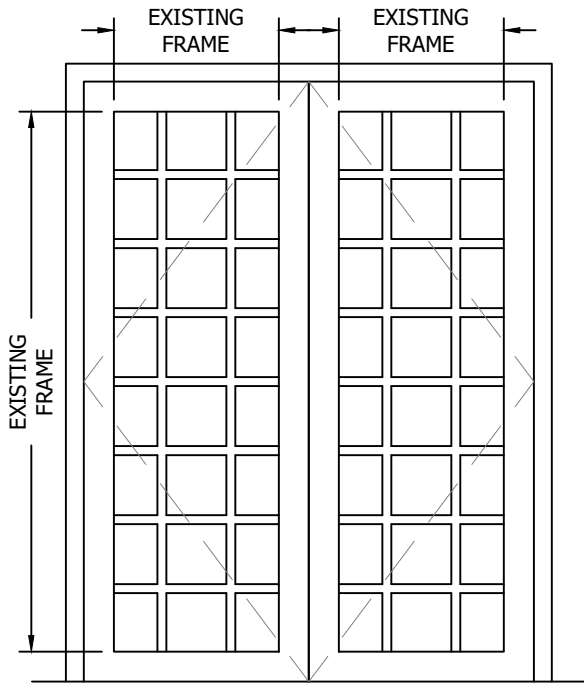

EXISTING WINDOW

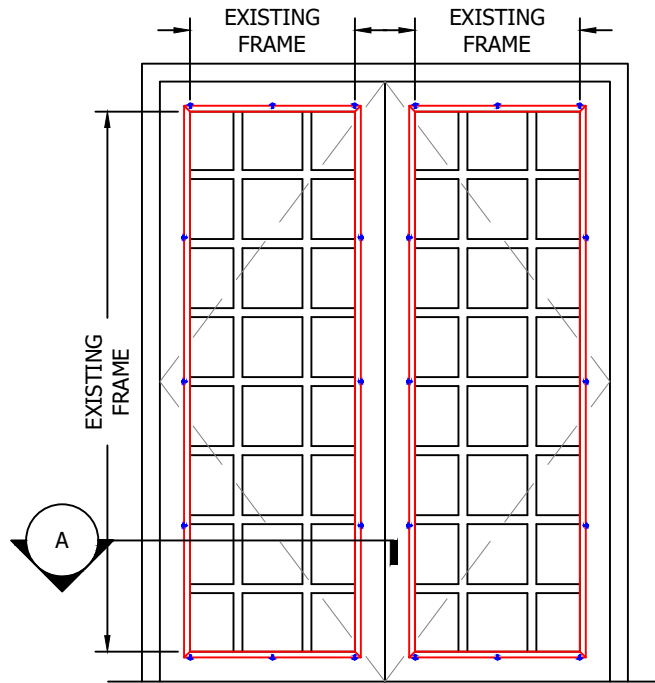

WINDOW ELEVATION

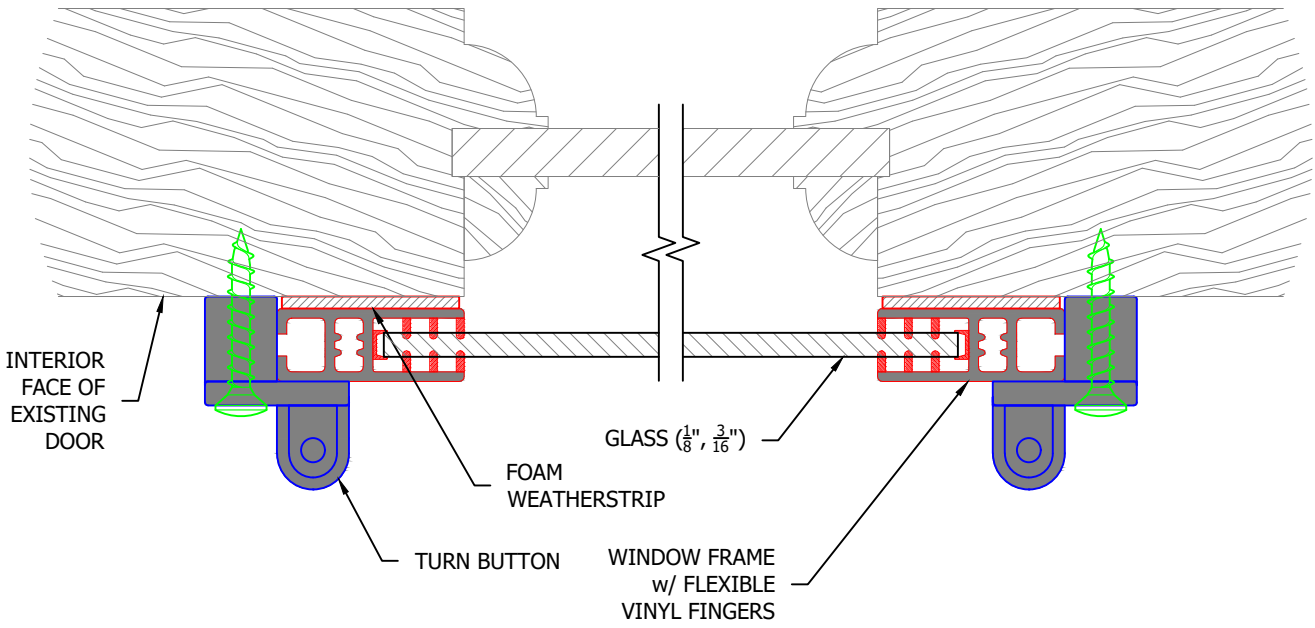

**A - FRAME**  
(FULL SCALE)

- AVAILABLE IN ALMOND, BROWN AND WHITE
- SEE ADDITIONAL DETAILS FOR OVERSIZED WINDOWS



**Innerglass**<sup>®</sup>  
Window Systems, LLC  
The Compression-Fit Advantage

PRODUCT CUT SHEET  
SURFACE MOUNT INTERIOR STORM WINDOW

DATE: 05/23/18

**SM**